



Micropower, Single-Supply, SOT23 Comparator + Precision Reference ICs

General Description

The MAX9040–MAX9043 and MAX9050–MAX9053 feature combinations of low-power comparators and precision voltage references. Their operating voltage range makes them ideal for both +3V and +5V systems. The MAX9040/MAX9041/MAX9050/MAX9051 have a single comparator and reference consuming only 40 μ A of supply current. The MAX9042/MAX9043/MAX9052/MAX9053 have dual comparators and one reference, and consume only 55 μ A of supply current. Low-voltage operation and low supply current make these devices ideal for battery-operated systems.

The comparators feature Rail-to-Rail® inputs and outputs, with a common-mode input voltage range that extends 250mV beyond the supply rails. Input bias current is typically 1.0pA, and input offset voltage is typically 0.5mV. Internal hysteresis ensures clean output switching, even with slow-moving input signals. The output stage features a unique design that limits supply current surges while switching, virtually eliminating supply glitches typical of many other comparators. This design also minimizes overall power consumption under dynamic conditions. The comparator outputs have rail-to-rail push-pull output stages that sink and source up to 8mA. The propagation delay is 400ns, even with the low operating supply current.

The reference output voltage is set to 2.048V in the MAX9040–MAX9043 and to 2.500V in the MAX9050–MAX9053. These devices are offered in two grades: an A grade with 0.4% initial accuracy and 6ppm/°C tempco, and a B grade with 1% initial accuracy and 100ppm/°C tempco. The voltage reference features a proprietary curvature-correction circuit and laser-trimmed thin-film resistors. The series-mode references can sink or source up to 500 μ A of load current.

Applications

Precision Battery Management
Window Comparators
IR Receivers
Level Translators
Digital Line Receivers

Typical Operating Circuit appears at end of data sheet.

Functional Diagrams appear at end of data sheet.

Selector Guide appears at end of data sheet.

Rail-to-Rail is a registered trademark of Nippon Motorola, Ltd.



Features

- ◆ Comparator + Precision Reference in SOT23
- ◆ +2.5V to +5.5V Single-Supply Operation (MAX9040–MAX9043)
- ◆ Low Supply Current (MAX9040/MAX9050)
 - 40 μ A Quiescent
 - 50 μ A with 100kHz Switching
- ◆ 400ns Propagation Delay
- ◆ Rail-to-Rail Inputs
- ◆ Rail-to-Rail Output Stage Sinks and Sources 8mA
- ◆ Internal \pm 3mV Hysteresis
- ◆ Voltage Reference Offers
 - \pm 0.4% max Initial Accuracy (A grade)
 - 6ppm/°C typ Temperature Coefficient (A grade)
 - Stable for 0nF to 4.7nF Capacitive Loads

Ordering Information

PART	TEMP. RANGE	PIN-PACKAGE	TOP MARK
MAX9040AEUK-T	-40°C to +85°C	5 SOT23-5	ADNV
MAX9040BEUK-T	-40°C to +85°C	5 SOT23-5	ADNX
MAX9041AEUT-T	-40°C to +85°C	6 SOT23-6	AAHF
MAX9041BEUT-T	-40°C to +85°C	6 SOT23-6	AAHH
MAX9041AESA	-40°C to +85°C	8 SO	—
MAX9041BESA	-40°C to +85°C	8 SO	—
MAX9042AEUA	-40°C to +85°C	8 μ MAX	—
MAX9042BEUA	-40°C to +85°C	8 μ MAX	—
MAX9042AESA	-40°C to +85°C	8 SO	—
MAX9042BESA	-40°C to +85°C	8 SO	—
MAX9043AEUB	-40°C to +85°C	10 μ MAX	—
MAX9043BEUB	-40°C to +85°C	10 μ MAX	—

Ordering Information continued at end of data sheet.

Pin Configurations

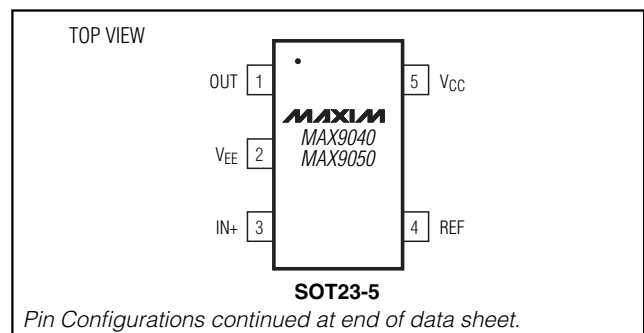

MAX9040–MAX9043/MAX9050–MAX9053

Micropower, Single-Supply, SOT23 Comparator + Precision Reference ICs

ABSOLUTE MAXIMUM RATINGS

Supply Voltage (V _{CC} to V _{EE})	-0.3V to +6V	8-Pin μMAX (derate 4.1mW/°C above +70°C)	330mW
All Other Pins	(V _{EE} - 0.3V) to (V _{CC} + 0.3V)	10-Pin μMAX (derate 5.6mW/°C above +70°C)	444mW
Output Short-Circuit Duration (OUT ₋ , REF)	Indefinite Short Circuit to Either Supply	8-Pin SO (derate 5.88mW/°C above +70°C)	471mW
Continuous Power Dissipation (T _A = +70°C)		Operating Temperature Range	-40°C to +85°C
5-Pin SOT23 (derate 7.10mW/°C above +70°C)	571mW	Junction Temperature	+150°C
6-Pin SOT23 (derate 8.70mW/°C above +70°C)	696mW	Storage Temperature Range	-65°C to +150°C
		Lead Temperature (soldering, 10s)	+300°C

Stresses beyond those listed under "Absolute Maximum Ratings" may cause permanent damage to the device. These are stress ratings only, and functional operation of the device at these or any other conditions beyond those indicated in the operational sections of the specifications is not implied. Exposure to absolute maximum rating conditions for extended periods may affect device reliability.

ELECTRICAL CHARACTERISTICS—A Grade (0.4% initial accuracy)

(V_{CC} = +5V, V_{EE} = 0, V_{CM} = 0, I_{OUT} = 0, I_{REF} = 0, T_A = T_{MIN} to T_{MAX}, unless otherwise noted. Typical values are at T_A = +25°C.) (Note 1)

PARAMETER	SYMBOL	CONDITIONS		MIN	TYP	MAX	UNITS
Supply Voltage Range (Note 2)	V _{CC}	MAX9040-MAX9043		2.5		5.5	V
		MAX9050-MAX9053		2.7		5.5	
Supply Current	I _{CC}	MAX9040/MAX9041/ MAX9050/MAX9051	V _{CC} = 2.7V		47	67	μA
			V _{CC} = 5.0V		52	72	
		MAX9042/MAX9043/ MAX9052/MAX9053	V _{CC} = 2.7V		55	80	
			V _{CC} = 5.0V		60	85	
COMPARATORS							
Input Offset Voltage (Note 3)	V _{OS}	Over entire common-mode range	T _A = +25°C		±0.5	±5.0	mV
			T _A = -40°C to +85°C			±7.0	
Input Hysteresis	V _{HYST}				±3.0		mV
Input Bias Current (Notes 4, 5, 6)	I _B	Specified common-mode range			±0.001	±10.0	nA
Input Offset Current (Note 4)	I _{OS}	Specified common-mode range			±0.5		pA
Common-Mode Voltage Range (Notes 4, 7)	CMVR	T _A = +25°C		V _{EE} - 0.25		V _{CC} + 0.25	V
		T _A = -40°C to +85°C		V _{EE}		V _{CC}	
Common-Mode Rejection Ratio (Note 4)	CMRR	Specified common-mode range		52	80		dB
		Power-Supply Rejection Ratio	PSRR	MAX9040-MAX9043, 2.5V ≤ V _{CC} ≤ 5.5V	55	80	
				MAX9050-MAX9053, 2.7V ≤ V _{CC} ≤ 5.5V	55	80	
Input Capacitance (Note 4)	C _{IN}				2.5		pF
Output Short-Circuit Current	I _{SC}	V _{OUT} = V _{EE} or V _{CC}	V _{CC} = 5V		95		mA
			V _{CC} = 2.7V		35		
Output Voltage Low	V _{OL}	V _{CC} = 5V, I _{SINK} = 8mA			0.2	0.55	V
		V _{CC} = 2.7V, I _{SINK} = 3.5mA			0.15	0.4	
Output Voltage High	V _{OH}	V _{CC} = 5V, I _{SOURCE} = 8mA		4.45	4.85		V
		V _{CC} = 2.7V, I _{SOURCE} = 3.5mA		2.3	2.55		

Micropower, Single-Supply, SOT23 Comparator + Precision Reference ICs

MAX9040-MAX9043/MAX9050-MAX9053

ELECTRICAL CHARACTERISTICS—A Grade (0.4% initial accuracy) (continued)

($V_{CC} = +5V$, $V_{EE} = 0$, $V_{CM} = 0$, $I_{OUT} = 0$, $I_{REF} = 0$, $T_A = T_{MIN}$ to T_{MAX} , unless otherwise noted. Typical values are at $T_A = +25^\circ C$.) (Note 1)

PARAMETER	SYMBOL	CONDITIONS		MIN	TYP	MAX	UNITS
Output Rise/Fall Times	t_R/t_F	$C_L = 15pF$		40			ns
		$C_L = 50pF$		50			
		$C_L = 200pF$		80			
Output Propagation Delay (Note 8)	t_{PD+}/t_{PD-}	$C_L = 15pF$, $V_{CC} = 2.7V$	50mV overdrive	450		ns	
			100mV overdrive	400			
Power-Up Time	t_{PU}	Time to V_{OUT} valid logic state		20		μs	
VOLTAGE REFERENCE							
Output Voltage	V_{REF}	$T_A = +25^\circ C$	MAX9040-MAX9043	2.040	2.048	2.056	V
			MAX9050-MAX9053	2.490	2.500	2.510	
Output Voltage Temperature Coefficient (Note 9)	TCV_{REF}	$\mu MAX/SO$		6		30	ppm/ $^\circ C$
		SOT23		6		50	
Line Regulation	$\Delta V_{REF}/\Delta V_{CC}$	$2.5V \leq V_{CC} \leq 5.5V$, MAX9040-MAX9043		+50		+200	$\mu V/V$
		$2.7V \leq V_{CC} \leq 5.5V$, MAX9050-MAX9053		+50		+200	
Load Regulation	$\Delta V_{REF}/\Delta I_{REF}$	Sourcing: $0 \leq I_{REF} \leq 500\mu A$		2		4	$\mu V/\mu A$
		Sinking: $-500\mu A \leq I_{REF} \leq 0$		3.5		6	
Output Short-Circuit Current	I_{SC}	$V_{REF} = V_{EE}$ or V_{CC}		4		mA	
Thermal Hysteresis (Note 10)	T_{HYST}			130		ppm	
Long-Term Stability		1000h at $T_A = +25^\circ C$		50		ppm	
Noise Voltage	E_{OUT}	$f = 0.1Hz$ to $10Hz$		40		$\mu Vp-p$	
		$f = 10Hz$ to $10kHz$		105		$\mu VRMS$	
Ripple Rejection	$\Delta V_{REF}/\Delta V_{CC}$	$V_{CC} = 5V \pm 100mV$, $f = 120Hz$		84		dB	
Turn-On Settling Time	$t_R(V_{REF})$	To $V_{REF} = 1\%$ of final value		200		μs	
Capacitive Load Stability Range (Note 6)	$C_L(V_{REF})$			0	4.7		nF

ELECTRICAL CHARACTERISTICS—B Grade (1% initial accuracy)

($V_{CC} = +5V$, $V_{EE} = 0$, $V_{CM} = 0$, $I_{OUT} = 0$, $I_{REF} = 0$, $T_A = T_{MIN}$ to T_{MAX} , unless otherwise noted. Typical values are at $T_A = +25^\circ C$.) (Note 1)

PARAMETER	SYMBOL	CONDITIONS		MIN	TYP	MAX	UNITS
Supply Voltage Range (Note 2)	V_{CC}	MAX9040-MAX9043		2.5		5.5	V
		MAX9050-MAX9053		2.7		5.5	
Supply Current	I_{CC}	MAX9040/MAX9041/ MAX9050/MAX9051	$V_{CC} = 2.7V$	40		100	μA
			$V_{CC} = 5.0V$	45			
		MAX9042/MAX9043/ MAX9052/MAX9053	$V_{CC} = 2.7V$	55			
			$V_{CC} = 5.0V$	60		130	

Micropower, Single-Supply, SOT23 Comparator + Precision Reference ICs

ELECTRICAL CHARACTERISTICS—B Grade (1% initial accuracy) (continued)

($V_{CC} = +5V$, $V_{EE} = 0$, $V_{CM} = 0$, $I_{OUT} = 0$, $I_{REF} = 0$, $T_A = T_{MIN}$ to T_{MAX} , unless otherwise noted. Typical values are at $T_A = +25^\circ C$.) (Note 1)

PARAMETER	SYMBOL	CONDITIONS		MIN	TYP	MAX	UNITS
COMPARATOR							
Input Offset Voltage (Note 3)	V_{OS}	Over entire common-mode range			±1	±9.0	mV
Input Hysteresis	V_{HYST}				±3.0		mV
Input Bias Current (Notes 4, 5, 6)	I_B	Specified common-mode range			±0.001	±25.0	nA
Input Offset Current (Note 4)	I_{OS}	Specified common-mode range			±0.5		pA
Common-Mode Voltage Range (Notes 4, 7)	$CMVR$			V_{EE}		V_{CC}	V
Common-Mode Rejection Ratio (Note 4)	$CMRR$	Specified common-mode range		52	80		dB
Power-Supply Rejection Ratio	$PSRR$	MAX9040–MAX9043, $2.5V \leq V_{CC} \leq 5.5V$		55	80		dB
		MAX9050–MAX9053, $2.7V \leq V_{CC} \leq 5.5V$		55	80		
Input Capacitance (Note 4)	C_{IN}				2.5		pF
Output Short-Circuit Current	I_{SC}	$V_{OUT} = V_{EE}$ or V_{CC}	$V_{CC} = 5V$		95		mA
			$V_{CC} = 2.7V$		35		
Output Voltage Low	V_{OL}	$V_{CC} = 5V$, $I_{SINK} = 8mA$			0.2	0.55	V
		$V_{CC} = 2.7V$, $I_{SINK} = 3.5mA$			0.15		
Output Voltage High	V_{OH}	$V_{CC} = 5V$, $I_{SOURCE} = 8mA$		4.45	4.85		V
		$V_{CC} = 2.7V$, $I_{SOURCE} = 3.5mA$			2.55		
Output Rise/Fall Times	t_r/t_f	$C_L = 15pF$			40		ns
		$C_L = 50pF$			50		
		$C_L = 200pF$			80		
Output Propagation Delay (Note 8)	t_{PD+}/t_{PD-}	$C_L = 15pF$, $V_{CC} = 2.7V$	50mV overdrive		450		ns
			100mV overdrive		400		
Power-Up Time	t_{PU}	Time to V_{OUT} valid logic state			20		μs
VOLTAGE REFERENCE							
Output Voltage	V_{REF}	$T_A = +25^\circ C$	MAX9040–MAX9043	2.028	2.048	2.068	V
			MAX9050–MAX9053	2.475	2.500	2.525	
Output Voltage Temperature Coefficient (Note 9)	TCV_{REF}				20	100	ppm/°C
Line Regulation	$\frac{\Delta V_{REF}}{\Delta V_{CC}}$	$2.5V \leq V_{CC} \leq 5.5V$	MAX9040–MAX9043		+50	+200	μV/V
			MAX9050–MAX9053		+50	+200	
Load Regulation	$\frac{\Delta V_{REF}}{\Delta I_{REF}}$	Sourcing: $0 \leq I_{REF} \leq 500\mu A$			2	4	μV/mA
		Sinking: $-500\mu A \leq I_{REF} \leq 0$			3.5	6	
Output Short-Circuit Current	I_{SC}	$V_{REF} = V_{EE}$ or V_{CC}			4		mA
Thermal Hysteresis (Note 10)	$THYST$				130		ppm
Long-Term Stability		1000h at $T_A = +25^\circ C$			100		ppm

Micropower, Single-Supply, SOT23 Comparator + Precision Reference ICs

MAX9040-MAX9043/MAX9050-MAX9053

ELECTRICAL CHARACTERISTICS—B Grade (1% initial accuracy) (continued)

($V_{CC} = +5V$, $V_{EE} = 0$, $V_{CM} = 0$, $I_{OUT} = 0$, $I_{REF} = 0$, $T_A = T_{MIN}$ to T_{MAX} , unless otherwise noted. Typical values are at $T_A = +25^\circ C$.) (Note 1)

PARAMETER	SYMBOL	CONDITIONS	MIN	TYP	MAX	UNITS
Noise Voltage	E_{OUT}	$f = 0.1\text{Hz to }10\text{Hz}$		40		μV_{p-p}
		$f = 10\text{Hz to }10\text{kHz}$		105		μV_{RMS}
Ripple Rejection	$\frac{\Delta V_{REF}}{\Delta V_{CC}}$	$V_{CC} = 5V \pm 100\text{mV}$, $f = 120\text{Hz}$		84		dB
Turn-On Settling Time	$t_R(V_{REF})$	To $V_{REF} = 1\%$ of final value		200		μs
Capacitive Load Stability Range (Note 6)	$C_L(V_{REF})$		0		4.7	nF

Note 1: All devices are 100% production tested at $T_A = +25^\circ C$. Limits over the extended temperature range are guaranteed by design, not production tested.

Note 2: Supply voltage range guaranteed by PSRR test on comparator and line regulation of REF.

Note 3: V_{OS} is defined as the center of the input-referred hysteresis band.

Note 4: For the comparators with the inverting input (IN-) uncommitted.

Note 5: Input bias current is the average of the inverting and noninverting input bias currents.

Note 6: Not production tested. Guaranteed by design.

Note 7: Guaranteed by CMRR test.

Note 8: $V_{OVERDRIVE}$ is beyond the offset and hysteresis determined trip point.

Note 9: Temperature coefficient is measured by the box method; i.e., the maximum ΔV_{REF} is divided by the maximum ΔT .

Note 10: Thermal hysteresis is defined as the change in V_{REF} at $+25^\circ C$ before and after cycling the device from T_{MIN} to T_{MAX} .

Typical Operating Characteristics

($V_{CC} = +5V$, $V_{EE} = 0$, $V_{CM} = 0$, $I_{OUT} = 0$, $I_{REF} = 0$, $T_A = +25^\circ C$, unless otherwise noted.)

**MAX9040/MAX9041/MAX9050/MAX9051
SUPPLY CURRENT vs. TEMPERATURE**

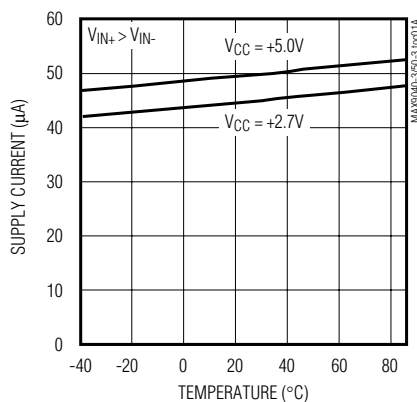

**MAX9042/MAX9043/MAX9052/MAX9053
SUPPLY CURRENT vs. TEMPERATURE**

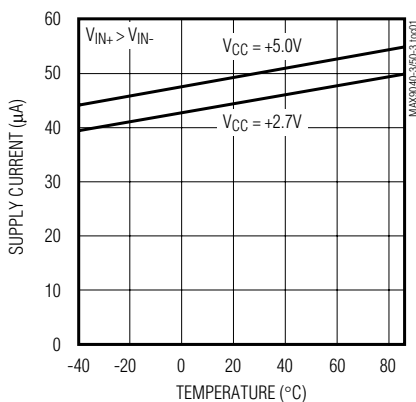

**MAX9040/MAX9041/MAX9050/MAX9051
SUPPLY CURRENT vs. SWITCHING FREQUENCY**

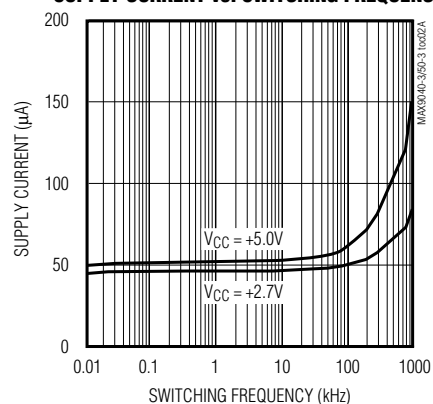

Micropower, Single-Supply, SOT23 Comparator + Precision Reference ICs

Typical Operating Characteristics (continued)

($V_{CC} = +5V$, $V_{EE} = 0$, $V_{CM} = 0$, $I_{OUT} = 0$, $I_{REF} = 0$, $T_A = +25^\circ C$, unless otherwise noted.)

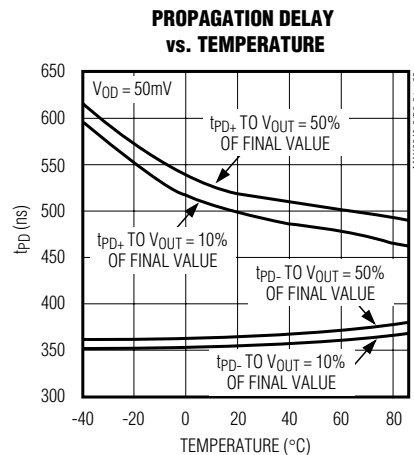
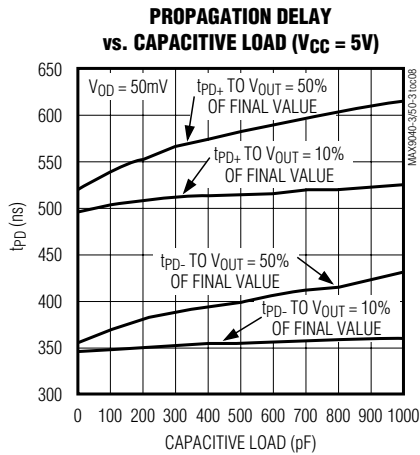
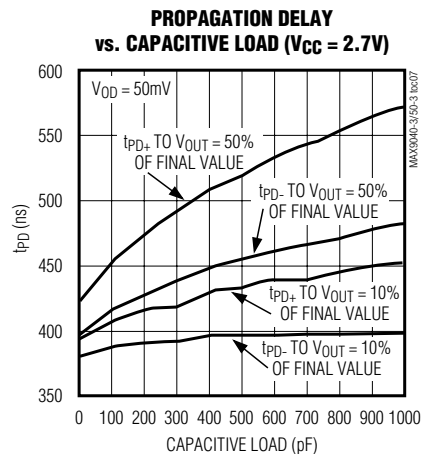
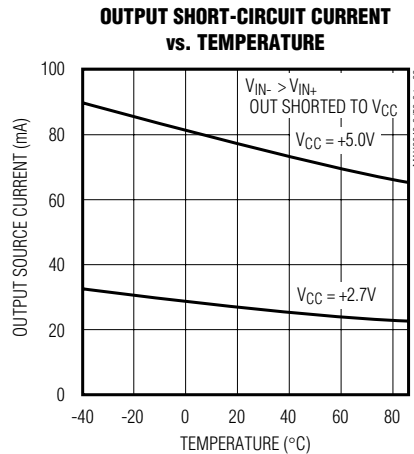
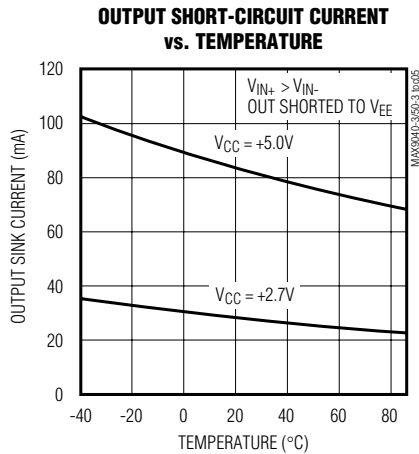
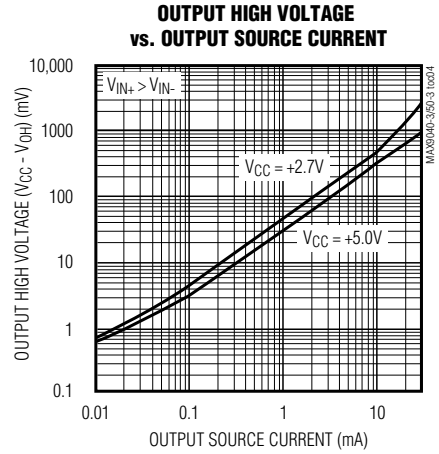
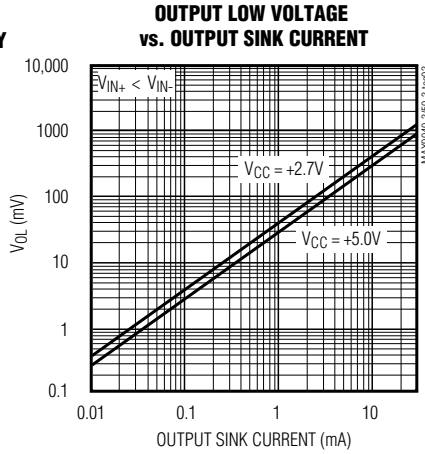
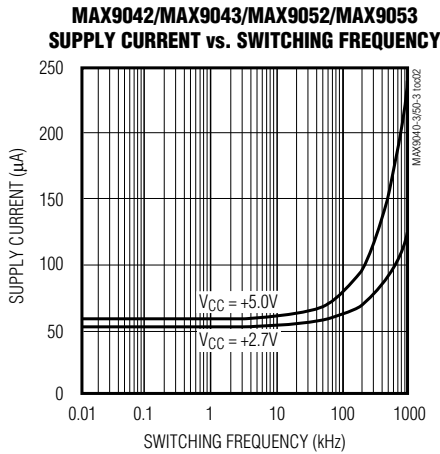

Micropower, Single-Supply, SOT23 Comparator + Precision Reference ICs

Typical Operating Characteristics (continued)

($V_{CC} = +5V$, $V_{EE} = 0$, $V_{CM} = 0$, $I_{OUT} = 0$, $I_{REF} = 0$, $T_A = +25^\circ C$, unless otherwise noted.)

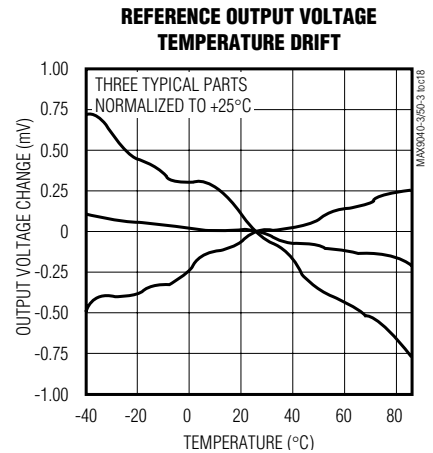
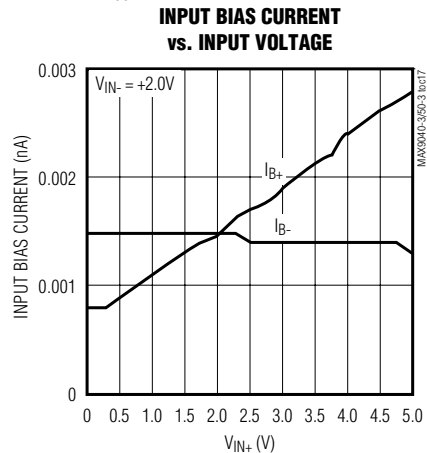
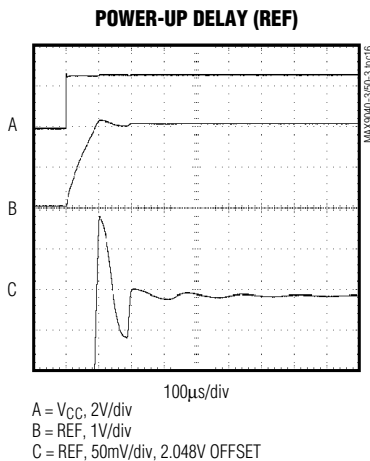
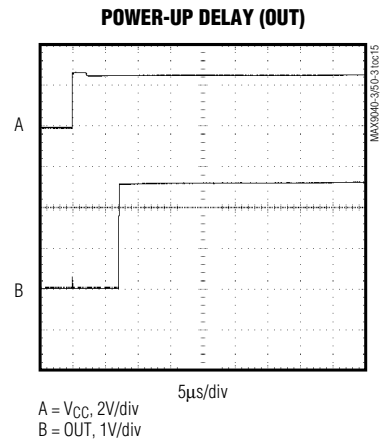
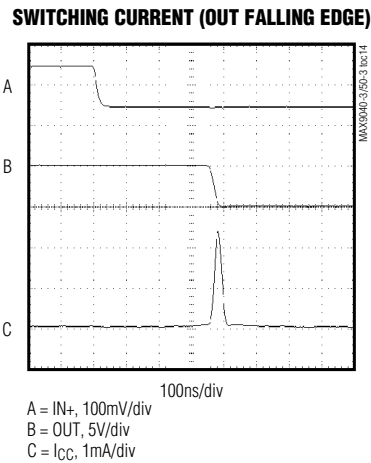
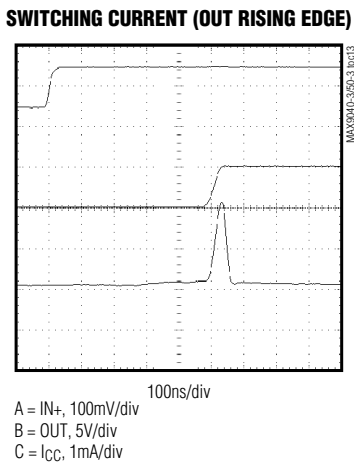
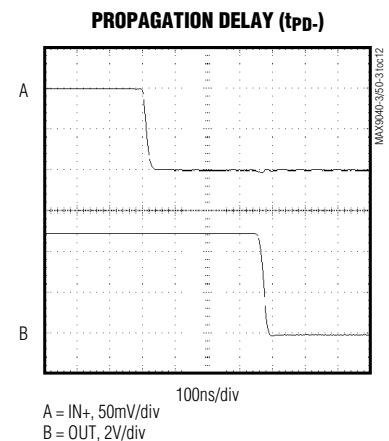
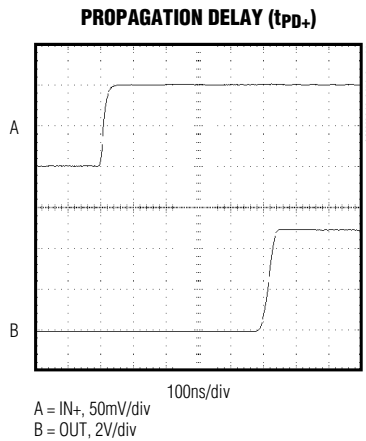
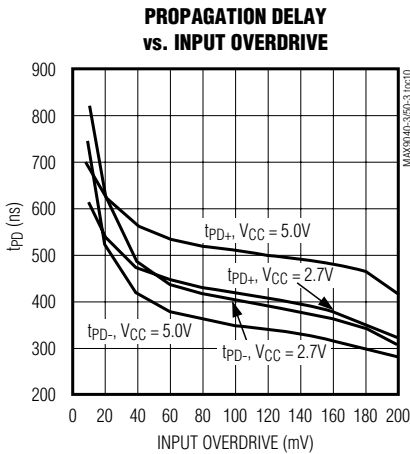

MAX9040-MAX9043/MAX9050-MAX9053

Micropower, Single-Supply, SOT23 Comparator + Precision Reference ICs

Typical Operating Characteristics (continued)

($V_{CC} = +5V$, $V_{EE} = 0$, $V_{CM} = 0$, $I_{OUT} = 0$, $I_{REF} = 0$, $T_A = +25^\circ C$, unless otherwise noted.)

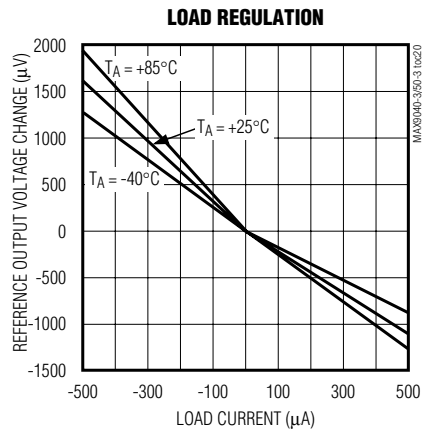
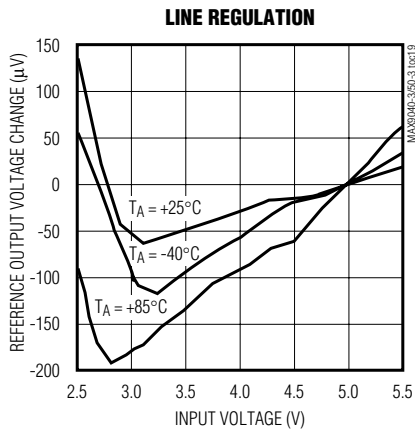

Pin Description

PIN					NAME	FUNCTION
MAX9040 MAX9050	MAX9041 MAX9051	MAX9042 MAX9052	MAX9043 MAX9053			
SOT23-5	SOT23-6	SO	SO/ μ MAX	μ MAX		
1	1	6	—	—	OUT	Comparator Output
2	2	4	4	5	V_{EE}	Negative Supply Voltage
3	3	3	—	—	IN+	Comparator Noninverting Input
4	5	1	2	2	REF	Reference Voltage Output
5	6	7	8	10	V_{CC}	Positive Supply Voltage
—	4	2	—	—	IN-	Comparator Inverting Input
—	—	5, 8	—	9	N.C.	No Connection. Not internally connected.
—	—	—	1	1	OUTA	Comparator A Output
—	—	—	3	4	INA+	Comparator A Noninverting Input
—	—	—	5	6	INB+	Comparator B Noninverting Input
—	—	—	6	7	INB-	Comparator B Inverting Input
—	—	—	7	8	OUTB	Comparator B Output
—	—	—	—	3	INA-	Comparator A Inverting Input

Micropower, Single-Supply, SOT23 Comparator + Precision Reference ICs

MAX9040-MAX9043/MAX9050-MAX9053

Detailed Description

The MAX9040–MAX9043 and MAX9050–MAX9053 feature single/dual, low-power, low-voltage comparators and a precision voltage reference. They operate from a single +2.5V to +5.5V (MAX904_) or +2.7V to +5.5V (MAX905_) supply. The single comparators with reference (MAX9040/MAX9041/MAX9050/MAX9051) consume only 40µA of supply current, while the dual comparators with reference (MAX9042/MAX9043/MAX9052/MAX9053) consume only 55µA of supply current. Their common-mode input range extends 0.25V beyond each rail. Internal hysteresis ensures clean output switching, even with slow-moving input signals.

The output stage employs a unique design that minimizes supply current surges while switching, virtually eliminating the supply glitches typical of many other comparators. Large internal output drivers allow rail-to-rail output swing that can sink and source up to 8mA of current.

The precision reference uses a proprietary curvature-correction circuit and laser-trimmed thin-film resistors, resulting in a temperature coefficient of less than 30ppm/°C over the extended temperature range and initial accuracy of 0.4% (A grade). The reference output voltage is set to 2.048V in the MAX9040–MAX9043 and to 2.500V in the MAX9050–MAX9053.

Comparator Input Stage Circuitry

The devices' input common-mode range extends from (V_{EE} - 0.25V) to (V_{CC} + 0.25V). These comparators may operate at any differential input voltage within these limits. Input bias current is typically 1.0pA if the input volt-

age is between the supply rails. Comparator inputs are protected from overvoltage by internal body diodes connected to the supply rails. As the input voltage exceeds the supply rails, these body diodes become forward biased and begin to conduct. Consequently, bias currents increase exponentially as the input voltage exceeds the supply rails.

Comparator Output Stage Circuitry

The comparators in these devices contain a unique output stage capable of rail-to-rail operation with loads up to 8mA. Many comparators consume orders-of-magnitude more current during switching than during steady-state operation. However, with this family of comparators, the supply current change during an output transition is extremely small. The *Typical Operating Characteristics* graph Supply Current vs. Switching Frequency shows the minimal supply current increase as the output switching frequency approaches 1MHz. This characteristic reduces the need for power-supply filter capacitors to reduce glitches created by comparator switching currents. Another advantage realized in high-speed, battery-powered applications is a substantial increase in battery life.

Applications Information

Additional Hysteresis

These comparators have ±3mV internal hysteresis. Additional hysteresis can be generated with two resistors using positive feedback (Figure 1). Use the following procedure to calculate resistor values:

- 1) Calculate the trip points of the comparator using these formulas:

$$V_{TH} = V_{REF} + \left(\frac{(V_{CC} - V_{REF})R_2}{R_1 + R_2} \right)$$

$$V_{TL} = V_{REF} \left(1 - \frac{R_2}{R_1 + R_2} \right)$$

V_{TH} is the threshold voltage at which the comparator switches its output from high to low as V_{IN} rises above the trip point. V_{TL} is the threshold voltage at which the comparator switches its output from low to high as V_{IN} drops below the trip point.

- 2) The hysteresis band will be:

$$V_{HYS} = V_{TH} - V_{TL} = V_{CC} \left(\frac{R_2}{R_1 + R_2} \right)$$

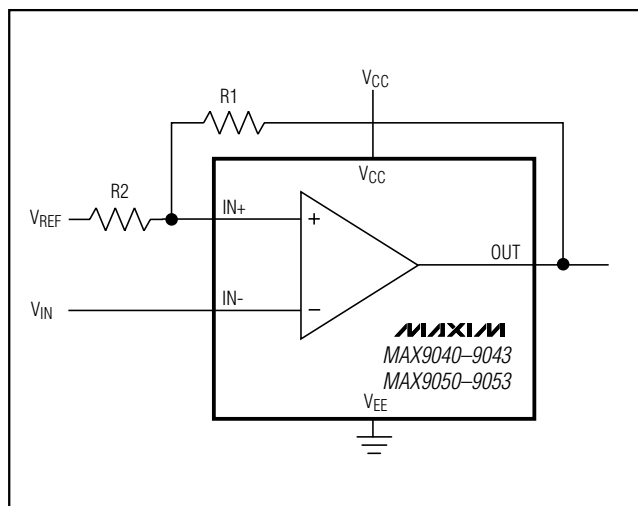

Figure 1. Additional Hysteresis

Micropower, Single-Supply, SOT23 Comparator + Precision Reference ICs

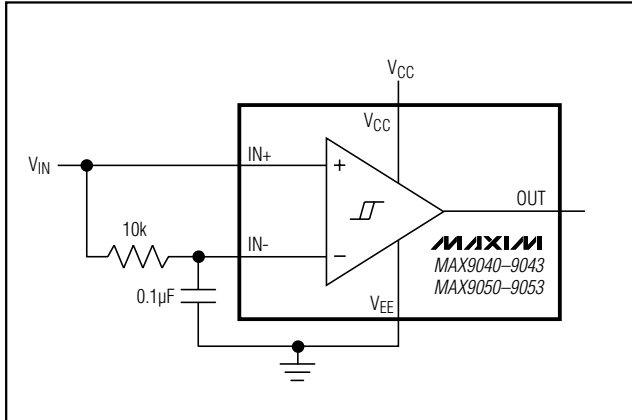

Figure 2. Time Averaging of the Input Signal for Data Recovery

3) In this example, let $V_{CC} = +5V$ and $V_{REF} = +2.5V$:

$$V_{TH} = 2.5 + 2.5 \left(\frac{R_2}{R_1 + R_2} \right)$$

and

$$V_{TL} = 2.5 \left(1 - \frac{R_2}{R_1 + R_2} \right)$$

- 4) Select R_2 . In this example, we will choose $1k\Omega$.
- 5) Select V_{HYS} . In this example, we will choose $50mV$.
- 6) Solve for R_1 :

$$V_{HYS} = V_{CC} \left(\frac{R_2}{R_1 + R_2} \right)$$

$$0.050 = 5 \left(\frac{1000}{R_1 + 1000} \right)$$

where $R_1 \approx 100k\Omega$, $V_{TH} = 2.525V$, and $V_{TL} = 2.475V$.

Board Layout and Bypassing

Power-supply bypass capacitors are not typically needed, but would be called for in cases where supply impedance is high, supply leads are long, or excessive noise is expected on the supply lines. Use $100nF$ bypass capacitors under these conditions. Minimize signal trace lengths to reduce stray capacitance.

Reference Output/Load Capacitance

The MAX904_/MAX905_ do not require an output capacitor on REF for frequency stability. They are stable for capacitive loads up to $4.7nF$. However, in applications where the load or the supply can experience step changes, an output capacitor will reduce the amount of overshoot (or undershoot) and assist the circuit's transient response. When an application is not subject to transient conditions, the REF capacitor can be omitted.

Biasing for Data Recovery

Digital data is often embedded into a bandwidth- and amplitude-limited analog path. Recovering the data can be difficult. Figure 2 compares the input signal to a time-averaged version of itself. This self-biases the threshold to the average input voltage for optimal noise margin.

Even severe phase distortion is eliminated from the digital output signal. Be sure to choose R_1 and C_1 so that:

$$f_{CAR} \gg \frac{1}{2\pi R_1 C_1}$$

where f_{CAR} is the fundamental carrier frequency of the digital data stream.

Chip Information

MAX9040/41/50/51 TRANSISTOR COUNT: 204
MAX9042/43/52/53 TRANSISTOR COUNT: 280

Micropower, Single-Supply, SOT23 Comparator + Precision Reference ICs

Selector Guide

MAX9040-MAX9043/MAX9050-MAX9053

PART	COMPARATORS PER PACKAGE	V _{REF} (V)	IN- CONNECTIONS
MAX9040	1	2.048	REF
MAX9041	1	2.048	Uncommitted
MAX9050	1	2.500	REF
MAX9051	1	2.500	Uncommitted
MAX9042	2	2.048	REF/Uncommitted
MAX9043	2	2.048	Uncommitted/Uncommitted
MAX9052	2	2.500	REF/Uncommitted
MAX9053	2	2.500	Uncommitted/Uncommitted

Pin Configurations (continued)

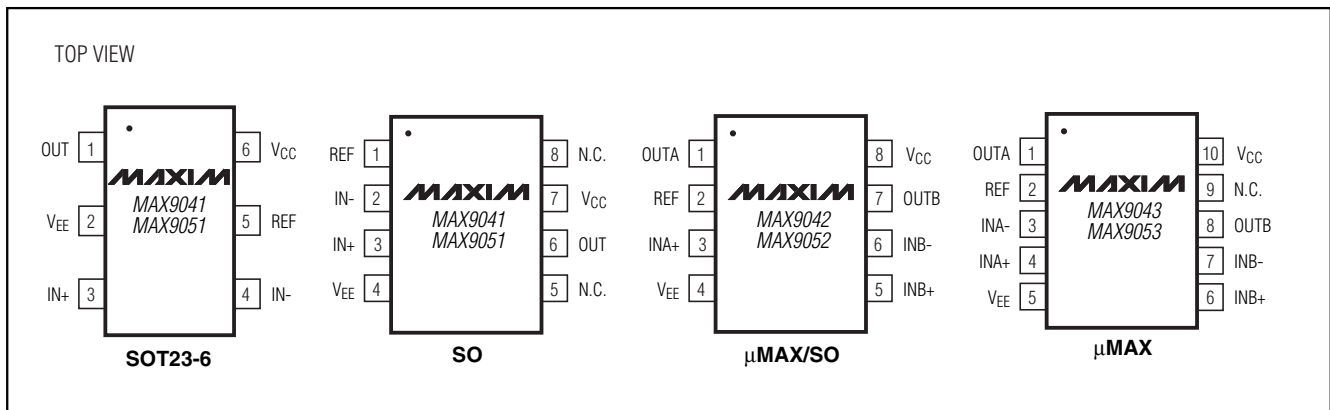

Ordering Information (continued)

PART	TEMP. RANGE	PIN-PACKAGE	TOP MARK
MAX9050AEUK-T	-40°C to +85°C	5 SOT23-5	ADNW
MAX9050BEUK-T	-40°C to +85°C	5 SOT23-5	ADNY
MAX9051AEUT-T	-40°C to +85°C	6 SOT23-6	AAHG
MAX9051BEUT-T	-40°C to +85°C	6 SOT23-6	AAHI
MAX9051AESAs	-40°C to +85°C	8 SO	—
MAX9051BESAs	-40°C to +85°C	8 SO	—
MAX9052AEUAs	-40°C to +85°C	8 μMAX	—
MAX9052BEUAs	-40°C to +85°C	8 μMAX	—
MAX9052AESAs	-40°C to +85°C	8 SO	—
MAX9052BESAs	-40°C to +85°C	8 SO	—
MAX9053AEUBs	-40°C to +85°C	10 μMAX	—
MAX9053BEUBs	-40°C to +85°C	10 μMAX	—

Typical Operating Circuit

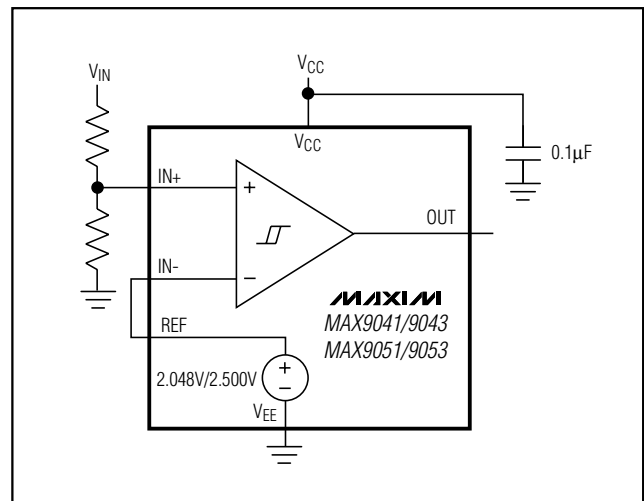

Micropower, Single-Supply, SOT23 Comparator + Precision Reference ICs

Functional Diagrams

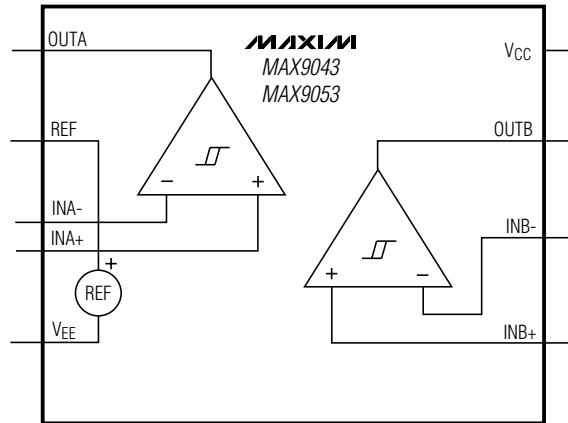
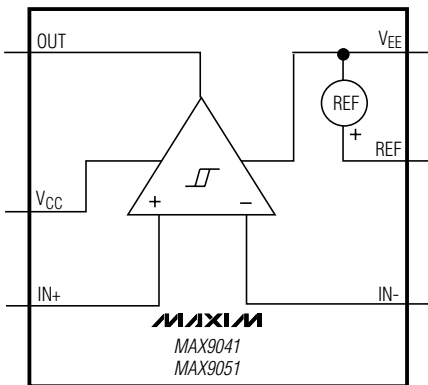
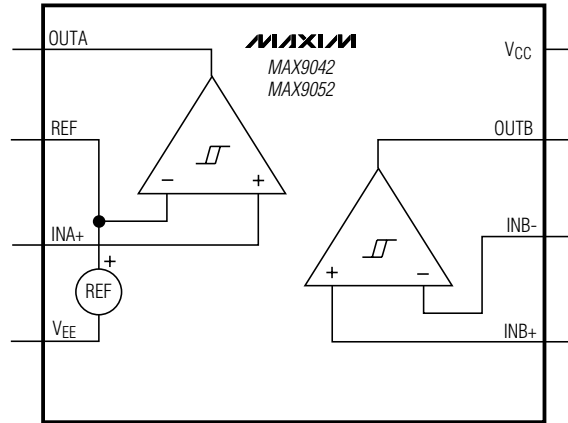
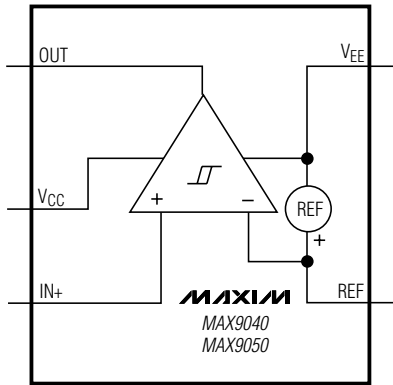

Maxim cannot assume responsibility for use of any circuitry other than circuitry entirely embodied in a Maxim product. No circuit patent licenses are implied. Maxim reserves the right to change the circuitry and specifications without notice at any time.

12 _____ **Maxim Integrated Products, 120 San Gabriel Drive, Sunnyvale, CA 94086 408-737-7600**